



Raccords PVC-U pression

COUDE 45° FEMELLE A COLLER-FILETEE AVEC JOINT ITEM 200



RÉFÉRENCE	DESCRIPTION	Poids net	Volume (m ³)	Poids brut	Unités par lot
1002152	CODO 45° ENCOLAR-R/M JUNTA 32-1"	0,0422	0,01553	4,4804	100
1002153	CODO 45° ENCOLAR-R/M JUNTA 40-1 1/4"	0,0764	0,02244	5,07	60
1002154	CODO 45° ENCOLAR-R/M JUNTA 50-1 1/2"	0,1232	0,02244	4,184	30
1002155	CODO 45° ENCOLAR-R/M JUNTA 63-2"	0,1975	0,03129	6,4219	30
1002156	CODO 45° ENCOLAR-R/M JUNTA 75-2 1/2"	0,34494	0,04717	10,99	30



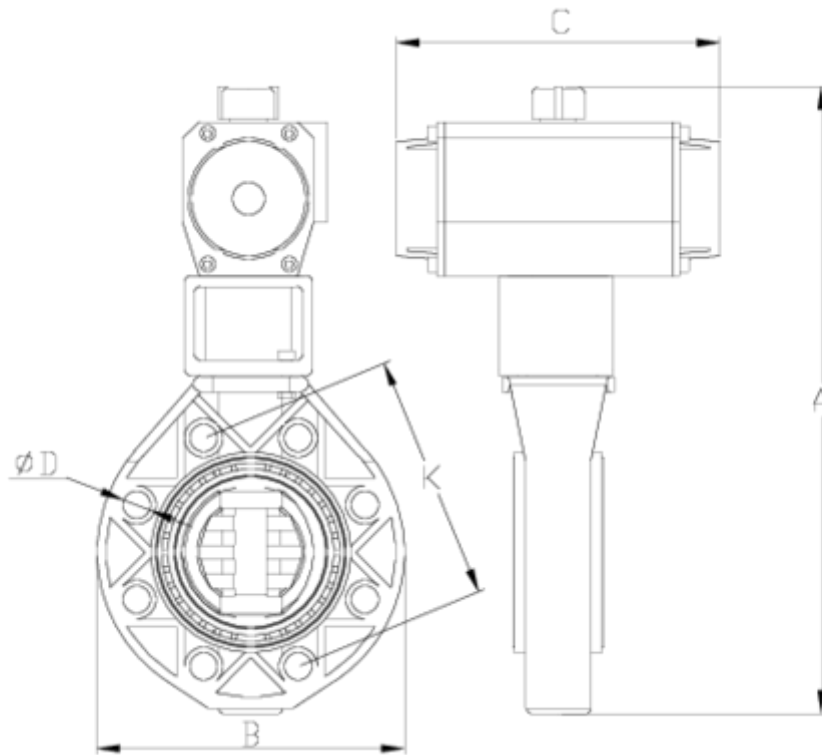

ITEM 200 | COUDE 45° FEMELLE A COLLER-FILETEE AVEC JOINT

CÓDIGO	A x a	PESO (g)	C	D	E	F	PN	MEDIDA
02152	32x1"	52	54	19	19	57	PN10	BSP
02153	40x1 1/4"	81	62	22	21	85	PN10	BSP
02154	50x1 1/2"	124	85	26	22	94	PN10	BSP
02155	63x2"	226	102	31	26	109	PN10	BSP
02156	75x2 1/2"	330	131	45	29	115	PN10	BSP





Documentation Produit



Certifications de produits



Certificats d'entreprise



Pol. Ind. Plá Vallonga,
c/ Agua, 28
03006 ALICANTE (España)



+34 965 11 42 82



+34 965 11 48 62



tecnicocomercial@hidroten.es



Service d'Attention
Technique Commerciale
+34 966 105 888



www.hidroten.es