



Válvulas de esfera 3 vías "Security"

Válv. de bola 3 vías "Security"

r/h FPM

ITEM 854

REFERÊNCIA	DESCRIÇÃO	Peso líquido	Volume (m ³)	Peso bruto	Unidades por lote
111V113	VALVULA União 3 VIAS L R/fêmea 1" FPM	0,681	0,03129	3,8579	4
111V115	VALVULA União 3 VIAS L R/fêmea 1 1/2" FPM	1,6964	0,04460	4,8669	2
111V116	VALVULA União 3 VIAS L R/fêmea 2" FPM	2,539	0,04460	6,5479	2
111V117	VALVULA União 3 VIAS L R/fêmea 2 1/2" FPM	4,9559	0,04836	6,746	1
111V153	VALVULA União 3 VIAS T R/fêmea 1" FPM	0,678	0,03129	3,8459	4
111V155	VALVULA União 3 VIAS T R/fêmea 1 1/2" FPM	1,6964	0,04460	4,8669	2
111V156	VALVULA União 3 VIAS T R/fêmea 2" FPM	2,539	0,04460	6,5479	2
111V157	VALVULA União 3 VIAS T R/fêmea 2 1/2" FPM	4,9559	0,04836	6,746	1



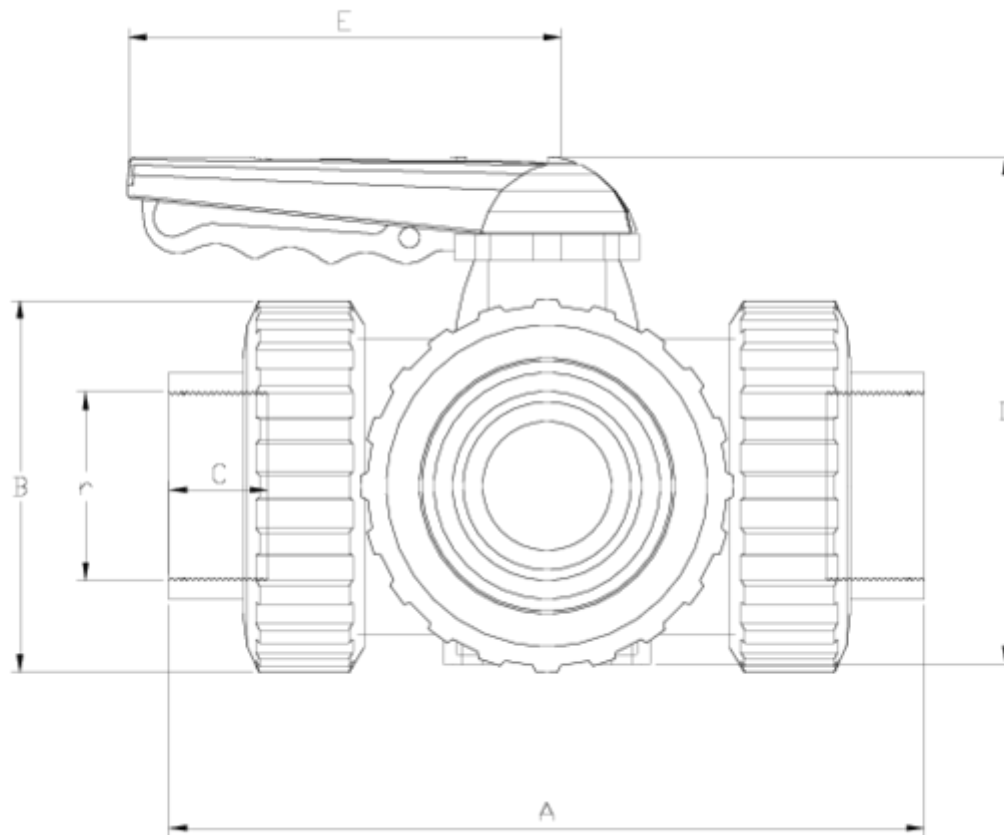

ITEM 854 | Válv. de bola 3 vías "Security" r/h FPM

VITÓN	r	PESO (g)	DN	Modelo	A	B	C	D	E	PN	TIPO ROSCA
11V113	1"	736	25	L	162	72	23	121	114	PN16	BSP
11V115	1 1/2"	1731	40	L	210	103	33	155	140	PN16	BSP
11V116	2"	2618	50	L	261	120	29	172	140	PN16	BSP
11V117	2 1/2"	5113	65	L	322	150	33	218	160	PN10	BSP
11V153	1"	732	25	T	162	72	23	121	114	PN16	BSP
11V155	1 1/2"	1721	40	T	210	103	33	155	140	PN16	BSP
11V156	2"	2600	50	T	261	120	29	172	140	PN16	BSP
11V157	2 1/2"	5073	65	T	322	150	33	218	160	PN10	BSP





Documentação do Produto



Certificados do Produto

Certificados da Empresa

